

**PCR L17 Stroke Order Activity:** Number and indicate the direction of each stroke for the characters below. Write the stroke number at the point where the stroke begins. Then add an arrow to indicate the writing direction from the starting point. Write the correct pinyin spelling for the character in the space provided. The first one has been done for you.

姓名 \_\_\_\_\_  
[xìng míng]: full name

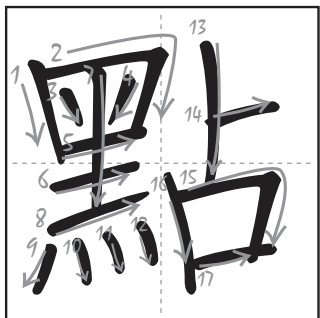

pinyin: diǎn

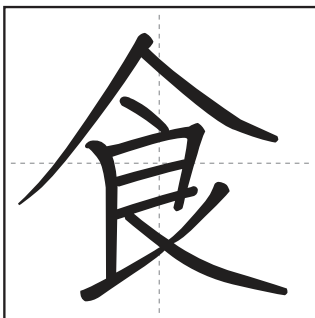

pinyin: \_\_\_\_\_



pinyin: \_\_\_\_\_

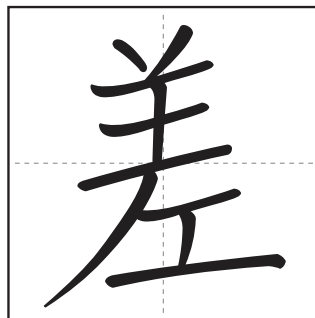

pinyin: \_\_\_\_\_

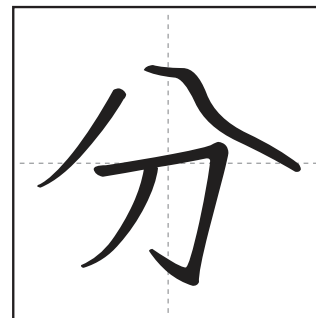

pinyin: \_\_\_\_\_

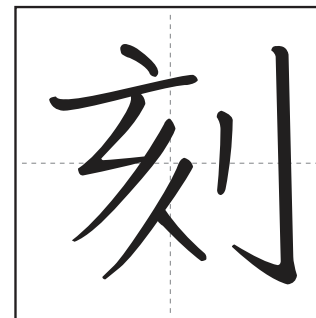

pinyin: \_\_\_\_\_

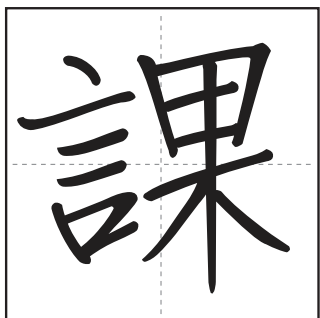

pinyin: \_\_\_\_\_

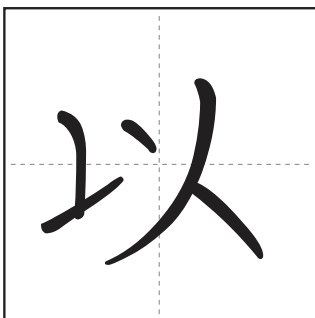

pinyin: \_\_\_\_\_



pinyin: \_\_\_\_\_

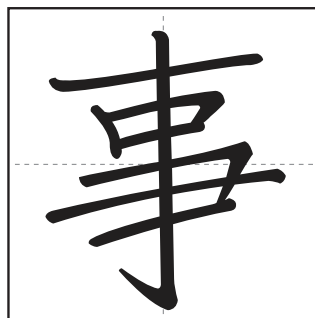

pinyin: \_\_\_\_\_

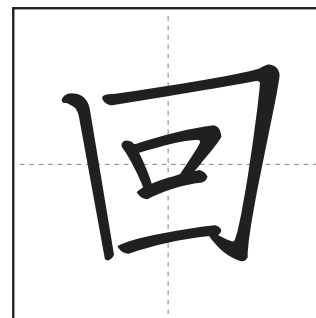

pinyin: \_\_\_\_\_

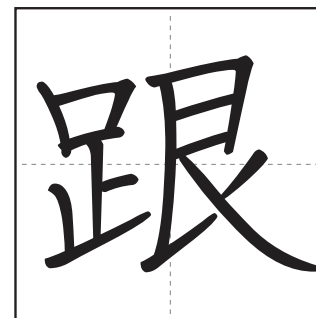

pinyin: \_\_\_\_\_



pinyin: \_\_\_\_\_



pinyin: \_\_\_\_\_

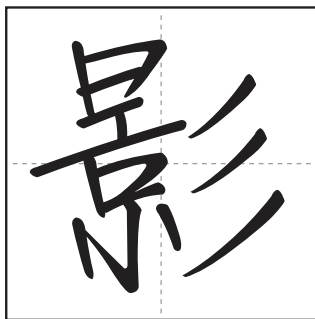

pinyin: \_\_\_\_\_

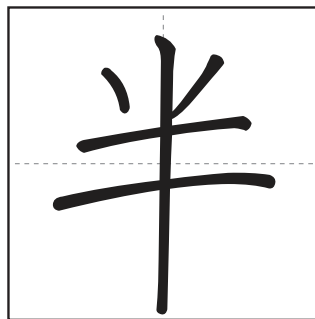

pinyin: \_\_\_\_\_



pinyin: \_\_\_\_\_

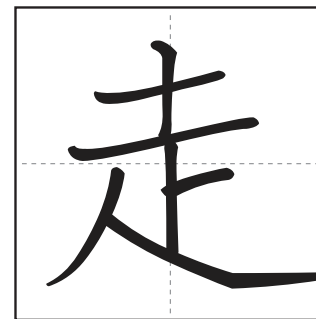

pinyin: \_\_\_\_\_